

Welcome to The Paper Dolls Saloon, home of the world famous Paper Dolls dancers, the dancingest girls this side o' the Mississip. It's time for another show, but after a raucous party last night, the girls' wardrobe is in a sorry state and they can't quite remember where to stand. Here's what they do know, at least as far as the audience sees it:

- Josephine and Ida May are best friends and always dance next to each other.
- Clara is a true patriot and will only wear red, white, or blue.
- One of the girls really likes the look of a brown corset beneath her green dress.
- The girl who dances on the left, next to the bar, dyed her hair to get the barkeep to notice her.
- During a stampede, the green dress was caught by a bull and torn on the left side.
- Josephine just bought a new red dress, but she's still not sure which dress she's going to wear tonight.
- The blond is not wearing a brown corset.
- The girl second from the left is a redhead.
- Clara left her dress and corset on the line to dry. During a shootout, a bandito blasted a hole clean through the left side of both garments.
- Annabelle has a girl on either side of her.
- The girl in the blue dress thinks it goes great with her black hair.
- During a barroom brawl last night, Annabelle had the midsection of her dress torn clean away.
- The stage manager likes variety and won't let the girls wear anything that matches their hair.
- The girl in the pink corset is not blond.
- Annabelle does not get on well with Ida May. To keep the peace, they always dance apart.
- Ida May's dress is in shambles after entertaining last night. She had to borrow a dress from a close friend.
- The girl second from the left hates purple.
- Tame Bill Hiccup, the barkeep, prefers blonds.
- On the way to the stage, Ida May catches her new dress on a nail, tearing the right side.
- Whoops, Josephine can't find her corset and has gone on stage without it.

The girls' outfits should hold out through the night, but if it gets any worse, the audience might just catch a glimpse of one of these.

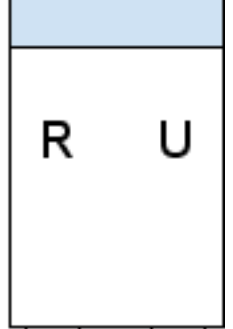
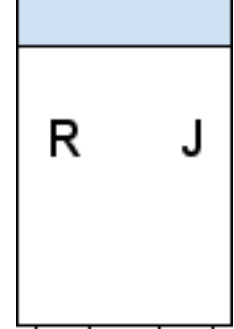
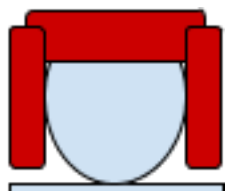
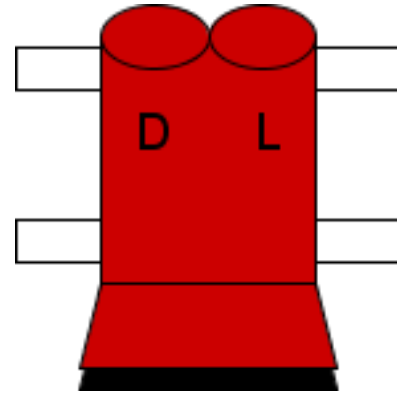
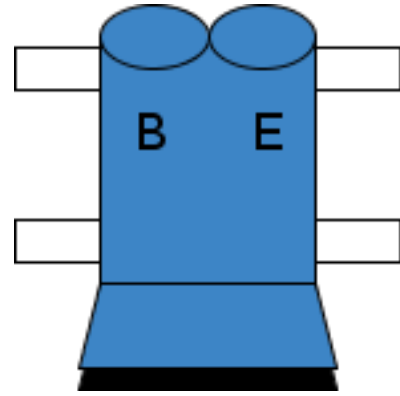
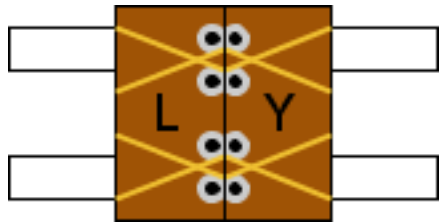
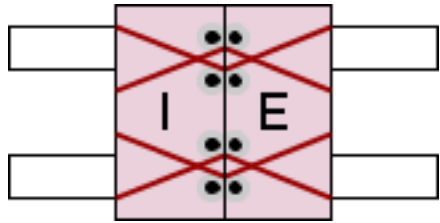
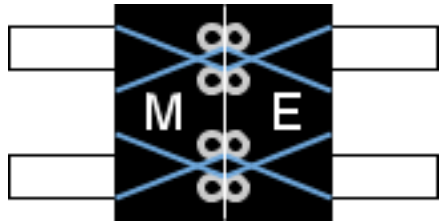
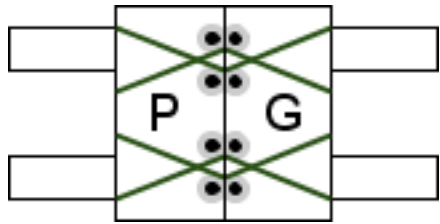

Josephine

Clara

Annabelle

Ida May

